

 Scala a chiocciola disponibile con forma tonda;  
Gradini in legno di faggio;  
Palo centrale in metallo;  
Ringhiera con colonne in acciaio verniciato;  
Corrimano:

1. **NOVA** in pvc effetto legno, tinta naturale o tinta noce, unico elemento continuo;
2. **NOVA CL** in legno massiccio suddiviso in settori.

 Spiral staircase available with round shape;  
Beech wood steps;  
Central pole in metal;  
Banister composed of painted steel columns;  
Handrail:

1. **NOVA** in wood-effect PVC, natural or walnut colored, a single continuous element;
2. **NOVA CL** made of solid wood divided into sectors.

 Escalier en colimaçon disponible ronde;  
Marches en bois de hêtre ;  
Poteau central en métal;  
Rampe avec colonnes en acier vernissé;  
Main courante:

1. **NOVA** en PVC effet bois, couleur naturel ou noyer, un seul élément continu;
2. **NOVA CL** en bois massif divisé en secteurs.

 Spindeltreppe mit runder Form erhältlich;  
Stufen aus Buchenholz;  
Zentralstange aus Metall;  
Geländer mit lackierten Stahlsäulen;  
Geländer:

1. **NOVA** aus PVC in Holzoptik, Natur oder Nussbaumfarben, ein einziges durchgehendes Element;
2. **NOVA CL** aus Massivholz, unterteilt in Sektoren.

 Escalera de caracol disponible con forma redonda;  
Escalones de madera de haya;  
Poste central en metal;  
Barandilla con columnas de acero pintado;  
Barandilla:

1. **NOVA** en PVC efecto madera, color natural o nogal, un único elemento continuo;
2. **NOVA CL** fabricado en madera maciza dividida en sectores.

## Dettagli tecnici Technical details - Détails techniques Technische Details - Ficha técnica

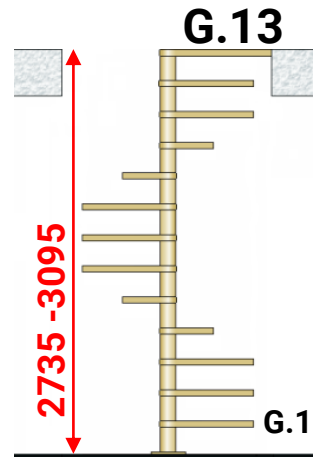
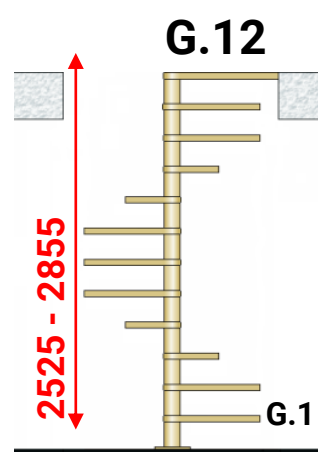
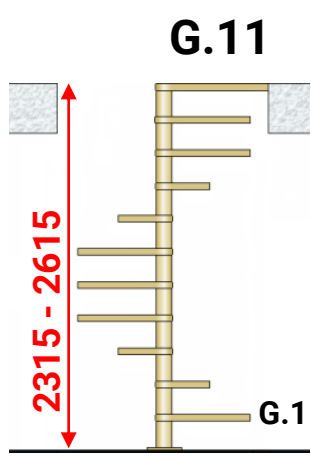

**IMBALLO**  
Dim. 115x97x74 cm  
Peso: circa 190/250 kg.

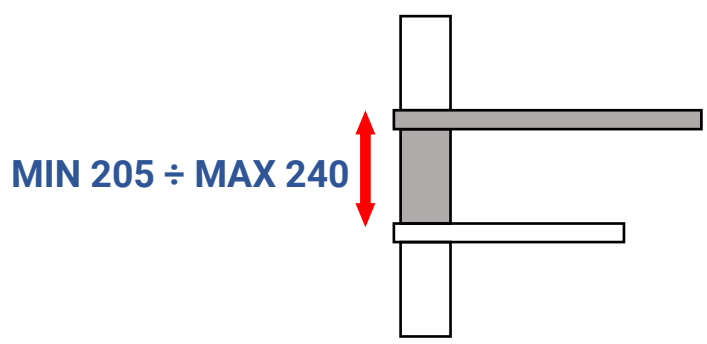
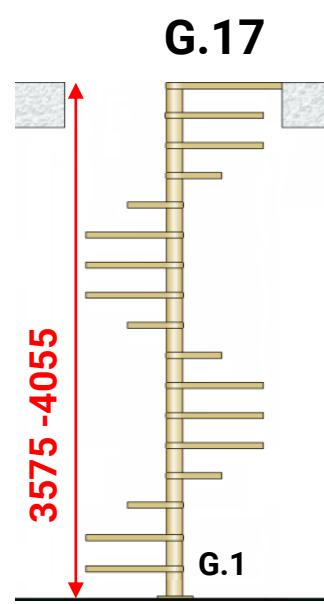
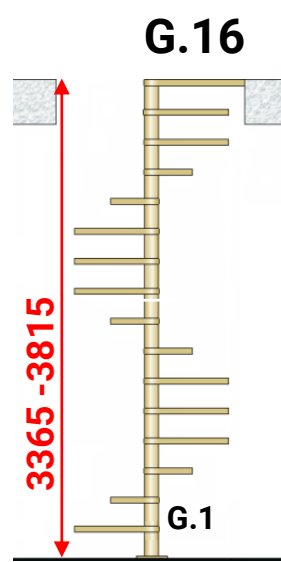
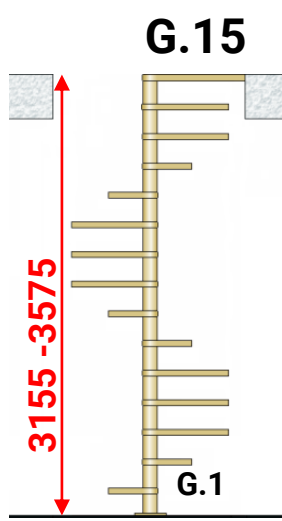
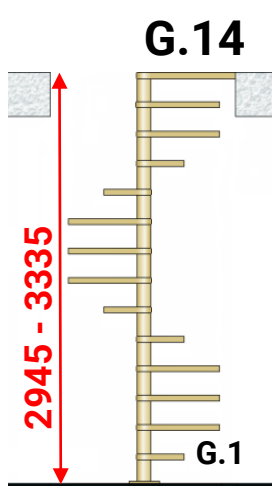

## Dettagli tecnici

### Technical details - Détails techniques

### Technische Details - Ficha técnica

L	C1	C3	P.U.	P.M.
Ø1200	675	649	480	157,9
Ø1400	773	743	580	165,7
Ø1600	873	838	680	189,1

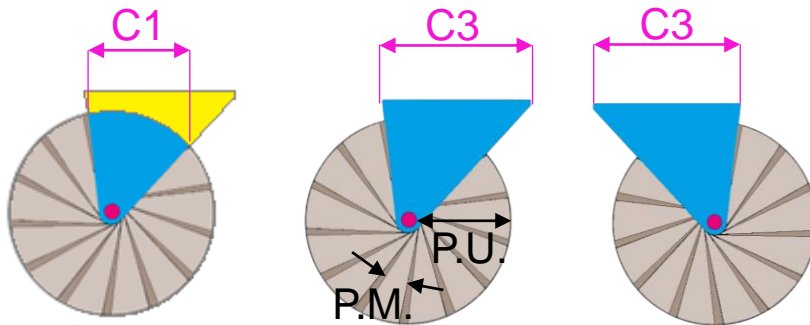

#### FORO, WELL, TRÊMIE, LOCH, HUECO

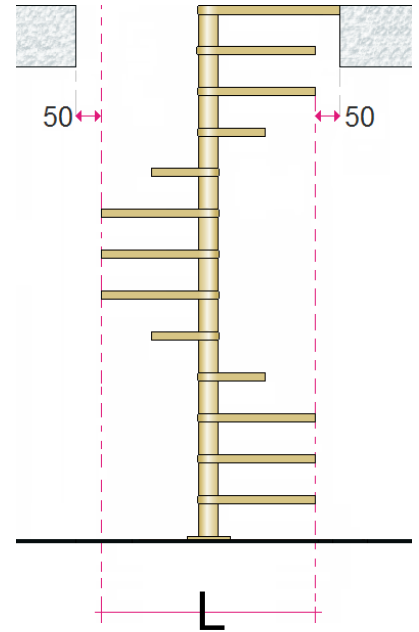

#### FISSAGGIO ARRIVO SBARCO, FIXING OF THE ARRIVAL LANDING, FIXATION DU PALIER D'ARRIVÉE, BEFESTIGUNG DES ANKUNFTSPODESTS

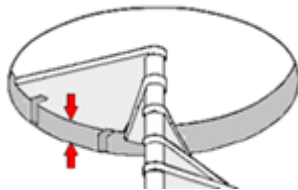

**MIN 210**

#### LEGNO, WOOD, BOIS, HOLZ, MADERA

#### APERTURA GRADINI, TREADS OPENING, OUVERTURE DES MARCHES, ÖFFNUNG DER STUFEN, APERTURA DE LOS ESCALONES



**Faggio**  
**Beech**  
**Hêtre**  
**Buche**  
**Haya**

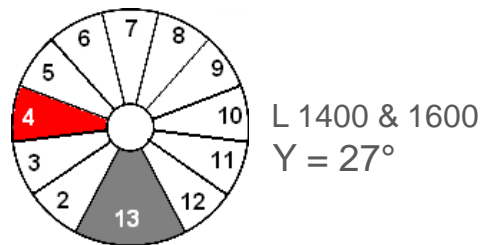
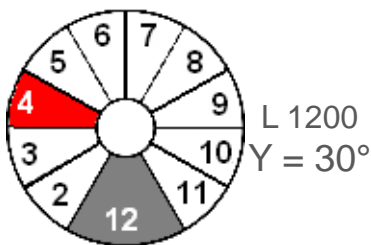

## NOVA T

Ø45 PVC effetto legno  
 PVC wood effect  
 PVC effet bois  
 PVC-Holzoptik  
 PVC efecto madera

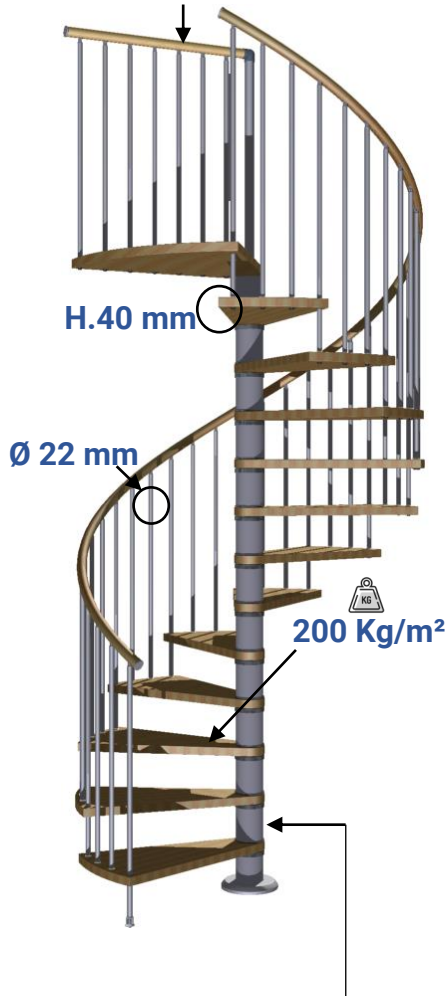

Metallo o legno – Ø127  
 Metal or wood - Métal ou bois  
 Metall oder Holz - Metal o madera

## NOVA CL

Ø45 Legno  
 Wood  
 Bois  
 Holz  
 Madera

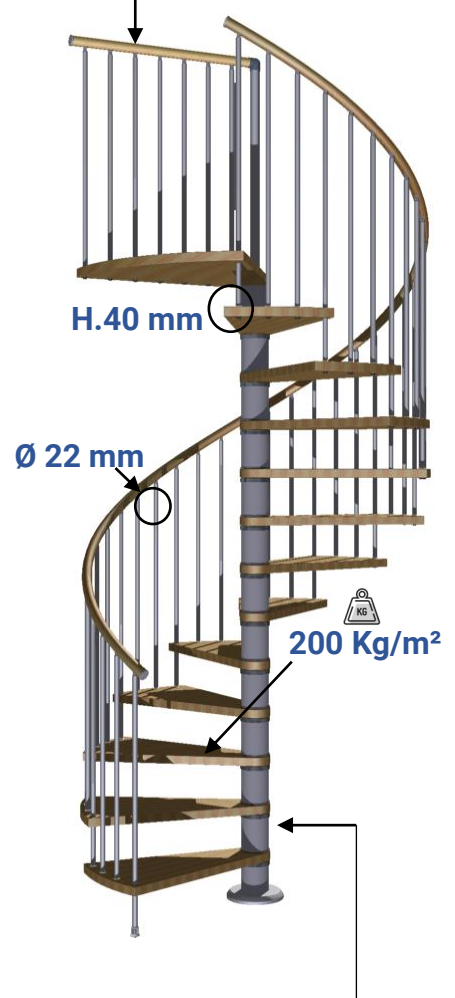

Metallo o legno – Ø127  
 Metal or wood - Métal ou bois  
 Metall oder Holz - Metal o madera

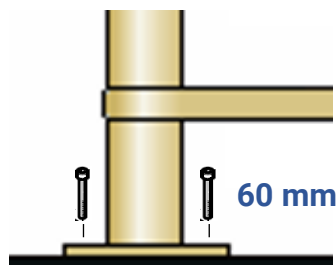

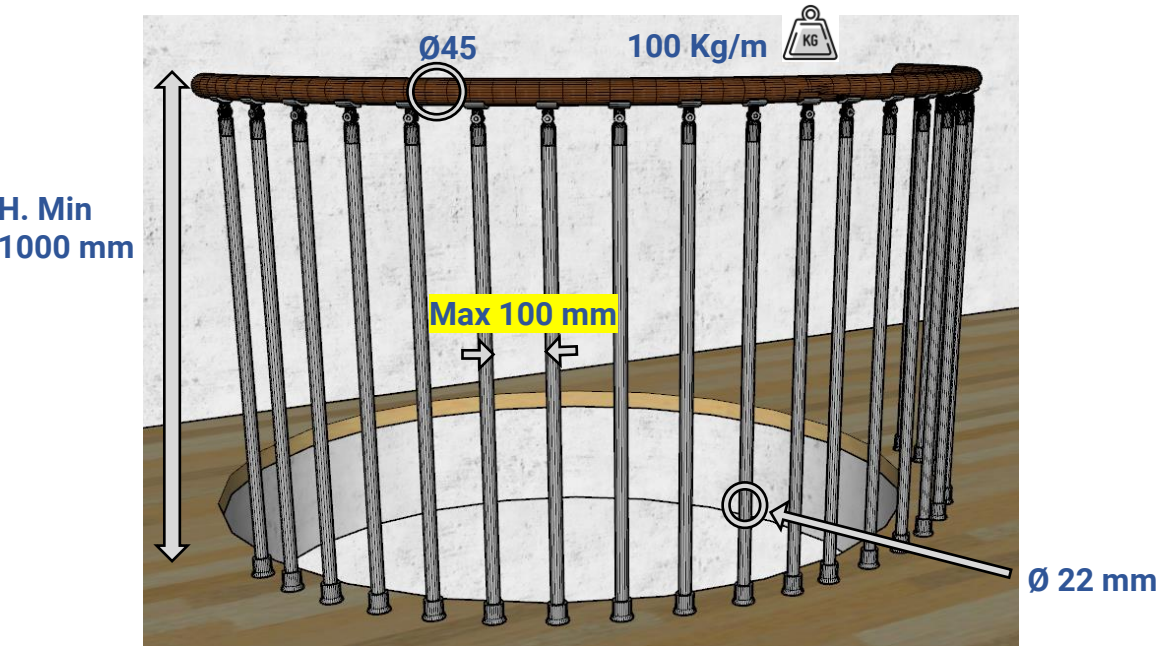
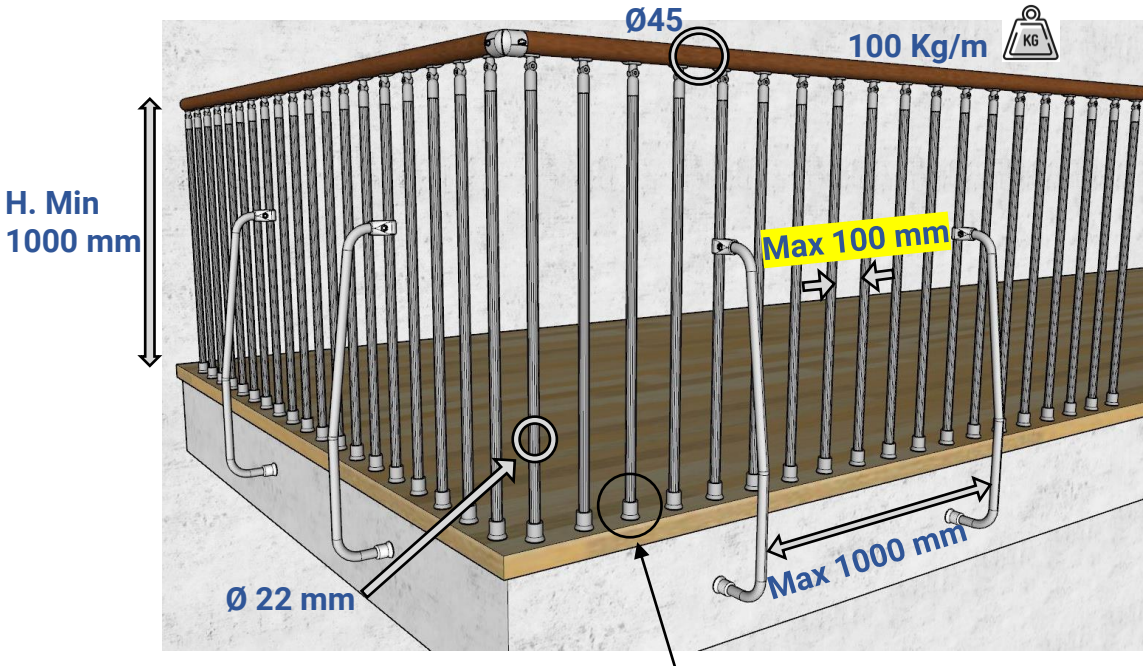

**CORRIMANI - Handrails - Mains courantes – Handläufe - Barandillas**



NOCE  
CHESTNUT  
NOYER



NATURALE  
NATURAL  
NATURELLE



Ø45 Legno  
Wood  
Bois  
Holz  
Madera

Ø45 PVC effetto legno  
PVC wood effect  
PVC effet bois  
PVC-Holzoptik  
PVC efecto madera



**Legno**  
Wood - Bois  
Holz - Madera



253 Naturale  
Natural  
Naturbuchenholz  
Couleur naturelle  
Natural



252 Noce medio  
Light chestnut  
Noyer moyen  
Nussbaumholz  
Nogal medio

**Metallo**

Metal  
Métal  
Metall  
Metal

**Componenti termoplastici**

Thermoplastic components  
Composants thermoplastiques  
Thermoplastische Bauteile

Componentes termoplásticos

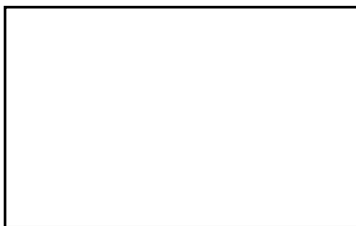

90 RG

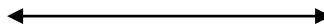

97 RG

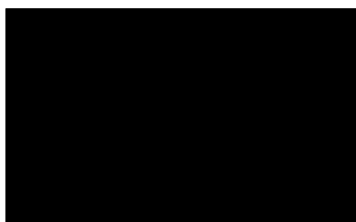

95 RG

